



Handläggande organ	Fastställt	Utgåva	Sida
SVENSK MATERIAL- & MEKANSTANDARD, SMS	2000-05-26	1	1 (14)

© Copyright SIS. Reproduction in any form without permission is prohibited.

## Woodworking machines – Two-, three- and four-side moulding machines – Nomenclature and acceptance conditions

The International Standard ISO 7947:1985 has the status of a Swedish Standard. This document contains the official English version of ISO 7947:1985.

Swedish Standards corresponding to documents referred to in this Standard are listed in "Catalogue of Swedish Standards", issued by SIS. The Catalogue lists, with reference number and year of Swedish approval, International and European Standards approved as Swedish Standards as well as other Swedish Standards.

## Träbearbetningsmaskiner – Hyvelmaskiner för samtidig bearbetning av två, tre och fyra sidor – Terminologi och acceptanskontroll

Den internationella standarden ISO 7947:1985 gäller som svensk standard. Detta dokument innehåller den officiella engelska versionen av ISO 7947:1985.

Motsvarigheten och aktualiteten i svensk standard till de publikationer som omnämns i denna standard framgår av "Katalog över svensk standard", som ges ut av SIS. I katalogen redovisas internationella och europeiska standarder som fastställts som svenska standarder och övriga gällande svenska standarder.

---

ICS 79.120.10

Standarder kan beställas hos SIS Förlag AB som även lämnar allmänna upplysningar om svensk och utländsk standard.  
Postadress: SIS, Box 6455, 113 82 STOCKHOLM  
Telefon: 08 - 610 30 00. Telefax: 08 - 30 77 57  
E-post: [sis.sales@sis.se](mailto:sis.sales@sis.se). Internet: [www.sisforlag.se](http://www.sisforlag.se)

Upplysningar om **sakinnehållet** i standarden lämnas av SMS.  
Telefon: 08 - 459 56 00. Telefax: 08 - 667 85 42  
E-post: [info@sms-standard.se](mailto:info@sms-standard.se)

Prisgrupp N

Tryckt i juli 2000

## Foreword

ISO (the International Organization for Standardization) is a worldwide federation of national standards bodies (ISO member bodies). The work of preparing International Standards is normally carried out through ISO technical committees. Each member body interested in a subject for which a technical committee has been established has the right to be represented on that committee. International organizations, governmental and non-governmental, in liaison with ISO, also take part in the work.

Draft International Standards adopted by the technical committees are circulated to the member bodies for approval before their acceptance as International Standards by the ISO Council. They are approved in accordance with ISO procedures requiring at least 75 % approval by the member bodies voting.

International Standard ISO 7947 was prepared by Technical Committee ISO/TC 39, *Machine tools*.

# Woodworking machines — Two-, three- and four-side moulding machines — Nomenclature and acceptance conditions

## 1 Scope and field of application

This International Standard specifies the nomenclature appropriate to each part of the machine and, with reference to ISO/R 230, both geometrical and practical tests for two-, three- and four-side moulding machines, and gives the corresponding permissible deviations which apply to machines for general purpose use and normal accuracy.

NOTE — In addition to terms used in two of the three official ISO languages (English and French), this International Standard gives in the annex the equivalent terms in German, Spanish, Italian and Swedish; these have been included at the request of Technical Committee ISO/TC 39 and are published under the responsibility of the member bodies for Germany, F.R. (DIN), Spain (IRANOR), Italy (UNI) and Sweden (SIS). However, only the terms and definitions given in the official languages can be considered as ISO terms and definitions.

This International Standard deals only with the verification of accuracy of the machine. It does not apply to the testing of the running of the machine (vibrations, abnormal noises, stick-slip motion of the components, etc.), nor to its characteristics (speeds, feeds, etc.) which should generally be checked before testing accuracy.

## 2 Reference

ISO/R 230, *Test code for machine tools*.

## 3 Preliminary remarks

**3.1** In this International Standard all dimensions and permissible deviations are expressed in millimetres.

**3.2** To apply this International Standard, reference should be made to ISO/R 230, especially for installation of the machine before testing, the warming up of the main spindle and other moving parts, and description of measuring methods. The measuring instruments shall not permit errors over 1/3 of the checked tolerances.

**3.3** The sequence in which the geometrical tests are given is related to the sub-assemblies of the machine and this in no way defines the practical order of testing. In order to make mounting of instruments or gauging easier, tests may be applied in any order.

**3.4** When inspecting a machine, it is not always possible or necessary to carry out all the tests given in this International Standard.

**3.5** It is up to the user to choose, in agreement with the manufacturer, those tests relating to the properties which are of interest to him, but these tests are to be clearly stated when ordering a machine.

**3.6** A movement is longitudinal when it takes place in the working direction of the piece.

**3.7** When establishing the tolerance for a measuring range different from that given in this International Standard (see 2.311 in ISO/R 230), it should be taken into consideration that the minimum value of the tolerance is 0,01 mm.

ISO 7947-1985 (E)

4 Nomenclature

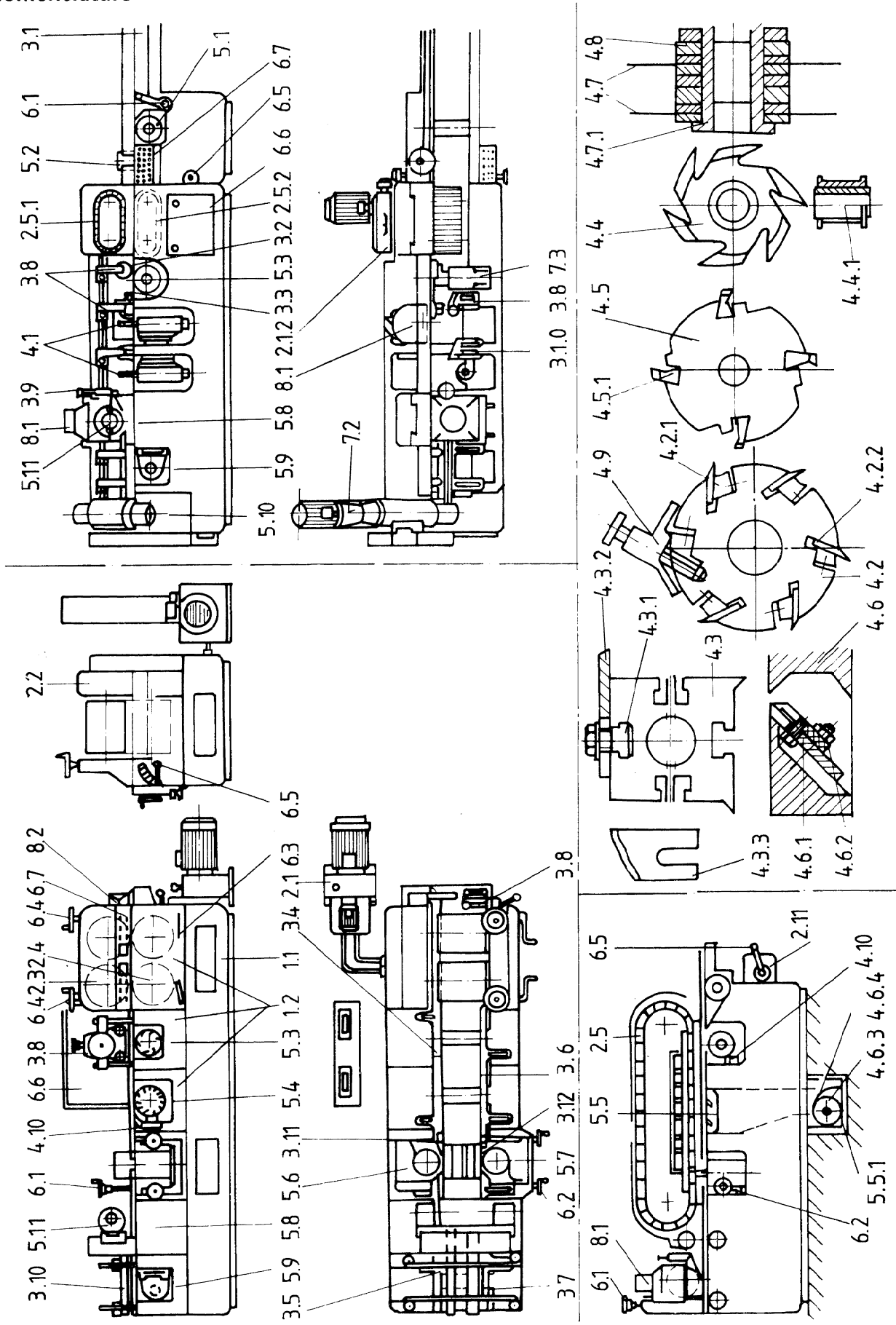

Reference	English	French
	Two-, three- and four-side moulding machine	Machine à moulurer sur deux, trois, quatre faces
1	<b>Framework</b>	<b>Ossature</b>
1.1	Main body	Bâti principal
1.2	Modular unit	Bâti modulaire
2	<b>Feed of workpiece and/or tools</b>	<b>Déplacement des pièces et/ou outils</b>
2.1	Feed drive	Commande de l'avance
2.1.1	Gear box	Boîte de vitesses
2.1.2	Stepless variator	Variateur de vitesse
2.2	Transmission housing	Coffre des transmissions
2.3	Top feed roller	Cylindre d'avance supérieur
2.4	Bottom feed roller	Cylindre d'avance inférieur
2.5	Feed chain	Chaîne d'avance
2.5.1	Top feed chain	Chaîne d'avance supérieure
2.5.2	Bottom feed chain (lag bed)	Chaîne d'avance inférieure
3	<b>Workpiece support, clamp, guide</b>	<b>Support, maintien et guidage des pièces</b>
3.1	Straightening table	Table de dégauchissage
3.2	Infeed table	Table d'entrée
3.3	Outfeed table	Table de sortie
3.4	Fence before side head	Guide de droite, d'entrée
3.5	Fence after side head	Guide de droite, après l'arbre porte-outils dresseur
3.6	Side pressure before side head	Guide presseur de gauche
3.7	Side pressure after side head	Guide de gauche, après l'arbre porte-outils vertical gauche
3.8	Roller pressure	Cylindre presseur
3.9	Top head chip breaker	Presseur avant l'arbre porte-outils horizontal supérieur
3.10	Near side head chip breaker	Presseur avant l'arbre porte-outils vertical gauche
3.11	Fence nose piece before fence side head	Presseur brise-copeaux de droite
3.12	Pressure nose piece before near side head	Presseur brise-copeaux de gauche
4	<b>Toolholders and tools</b>	<b>Porte-outils et outils</b>
4.1	Cutter spindle	Porte-outils
4.2	Circular cutter block	Porte-outils cylindrique
4.2.1	Wedge	Coin de serrage
4.2.2	Cutter (thin knife)	Lame mince
4.3	Square cutter block (with or without lips)	Porte-outils carré (avec ou sans lèvres)
4.3.1	Cutter bolt	Boulon de blocage de lame
4.3.2	Cutter (thick knife)	Lame épaisse
4.3.3	Profile knife	Lame profilée
4.4	Solid profile cutter	Outil monobloc à profiler
4.4.1	Mounting sleeve for solid profile cutter	Fourreau pour outil monobloc
4.5	Inserted profile cutter block	Porte-outils à profiler
4.5.1	Profile bit	Fer à profiler
4.6	Fixed knife cutter block	Porte-outils à dresser
4.6.1	Fixed knife cutter	Fer à dresser
4.6.2	Fixed knife chip breaker	Brise-copeaux de fer à dresser
4.6.3	Hogging cutter block	Déchiqueteur
4.6.4	Hogging cutter knife	Couteaux pour déchiqueteur
4.7	Splitting saw	Lame de scie circulaire
4.7.1	Splitting saw sleeve (or bush)	Flasque de serrage
4.8	Spacers	Rondelles d'écartement
4.9	Knife setting device	Appareil de réglage des lames minces
4.10	Jointing device	Dispositif de morfilage

ISO 7947-1985 (E)

Reference	English	French
	Two-, three- and four-side moulding machine	Machine à moulurer sur deux, trois, quatre faces
5	<b>Workheads and drives</b>	<b>Unité de travail et son entraînement</b>
5.1	Bottom (straightening) head	Arbre porte-outils de dégauchissage
5.2	Fence side (straightening) head	Arbre porte-outils dresseur de chant
5.3	Bottom head	Arbre porte-outils dessous
5.4	Multiknife finishing head	Arbre porte-outils de finition
5.5	Fixed knife box	Tiroir à fers à dresser
5.5.1	Chip hogger	Décheteur
5.6	Fence side head	Arbre porte-outils vertical de droite
5.7	Near side head	Arbre porte-outils vertical de gauche
5.8	Top head	Arbre porte-outils horizontal dessous
5.9	Beading head	Arbre porte-outils horizontal inférieur
5.10	Universal head	Arbre porte-outils horizontal universel
5.11	Outboard bearing	Palier extérieur
6	<b>Controls and adjustments</b>	<b>Commandes</b>
6.1	Vertical adjustment of cutter spindle or table	Réglage vertical de l'arbre porte-outils ou de la table
6.2	Horizontal adjustment of cutter spindle or fence	Réglage latéral de l'arbre porte-outils ou du guide
6.3	Adjustment of bottom feed rollers	Réglage des cylindres presseurs
6.4	Rise and fall adjustment of top feed rollers	Réglage en hauteur des cylindres d'avance
6.5	Adjustment of feed speed	Réglage de l'avance
6.6	Electrical control cabinet	Armoire de commande électrique
6.7	Control panel	Tableau de contrôle
7	<b>Safety devices (examples)</b>	<b>Dispositifs de sécurité (exemples)</b>
7.1	Brake	Frein
7.2	Transmission guards	Protection des transmissions
7.3	Cutter block guards	Protecteur pour outils
8	<b>Miscellaneous</b>	<b>Divers</b>
8.1	Exhaust hood	Buse d'aspiration
8.2	Double feed protection gate	Dispositifs interdisant l'introduction de deux pièces de bois
9	<b>Free</b>	<b>Libre</b>
10	<b>Examples of work</b>	<b>Exemples de travail</b>

5 Acceptance conditions and permissible deviations

5.1 Geometrical tests

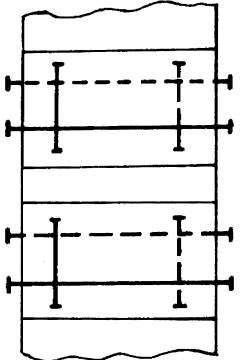
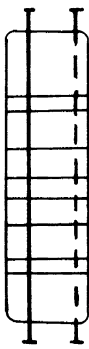
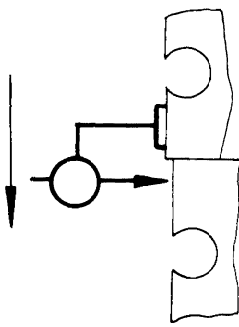
No.	Diagram	Object	Permissible deviation	Measuring instruments	Observations and reference to test code ISO/R 230
G1		<p>Checking flatness of individual table sections :</p> <p>a) longitudinal straightness</p> <p>b) transverse straightness</p>	<p>a) and b) 0,10 for pre-planing table</p> <p>0,20 for a measuring length of 1000</p>	<p>Straightedge and feeler gauges</p>	<p>Clause 5.322</p>
G2		<p>Checking of alignment of bed sections surfaces</p>	<p>0,10</p>	<p>Straightedge and feeler gauges</p>	
G3		<p>Checking of alignment of table sections transversely</p>	<p>0,03 excluding pre-planing table. Always lower in direction of feed</p>	<p>Dial gauge</p>	<p>Clause 5.412.2</p>

ISO 7947-1985 (E)

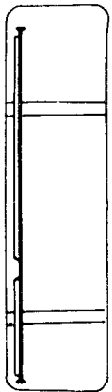
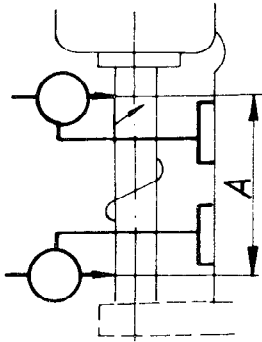
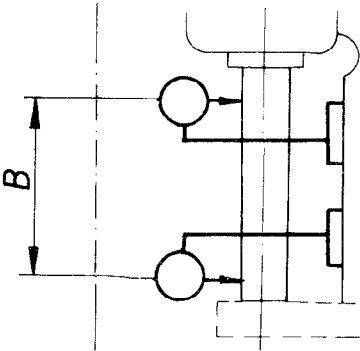
No.	Diagram	Object	Permissible deviation	Measuring instruments	Observations and reference to test code ISO/R 230
G4		Checking of straightness and alignment of fences	0,10 for a measuring length of 1000	Straightedge and feeler gauges	Clauses 5.212
G5		Measuring of run-out of horizontal spindles	0,02 for $A \leq 150$ 0,03 for $150 < A < 250$	Dial gauge	Clause 5.612.2 Checked with outboard bearing fitted if applicable.
G6		Checking of parallelism of horizontal spindles with respect to following table sections	0,05 for $B = 250$	Dial gauge	Clause 5.412.4 Checked with outboard bearing fitted if applicable.